



■ 介绍

CN8001 是用于驱动可逆电动机的 H 桥电动机驱动器，可驱动一个直流电动机，一个步进电动机的绕组或其他负载。

CN8001 在 2.5V 至 6V 的电动机电源电压下工作，根据逻辑控制，它可以提供高达 0.8A 的输出电流。

CN8001 由两个输入引脚控制。两个开/关输入确定输出模式：前进，后退，惯性停车或制动。当两个输入均处于低电平时，可以实现非常低的待机电路电流。

CN8001 提供 DFN2x2-8, SOT23-6, SOP-8 或 ESOP-8 封装。

■ 应用领域

- 智能断路器
- 智能锁
- 智能水/气表
- 玩具

■ 订单信息

零件号	封装	卷带式	标记*
CN8001DHR	DFN2x2-8	4000 /卷	CN8001/YYWW
CN8001TSR	SOT23-6	3000 /卷	01YW
CN8001SHR	SOP-8	2500 /卷	CN8001/YYWW
CN8001EHR	ESOP-8	2500 /卷	CN8001/YYWW

*注：YY / Y =年；WW / W =周；01 / CN8001 =产品名称

■ 特征

- 宽功率范围：2.5V 至 6V
- 0.8A 最大连续输出
- 高于 3A 的峰值电流能力
- 低 MOSFET 导通电阻：R_{hs} = 0.3Ω, R_{ls} = 0.15Ω
- 正向，反向，惯性或制动输出模式
- 适用于广泛的 MCU 控制逻辑
- 输入逻辑迟滞
- 热关断

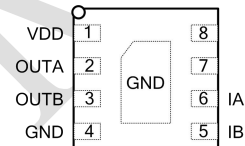

DFN2x2-8 Top View

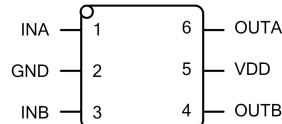

SOT23-6 Top View

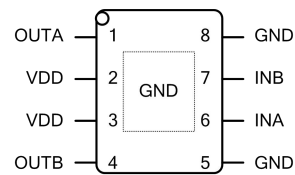

E/SOP-8 Top View



■ 简化框图

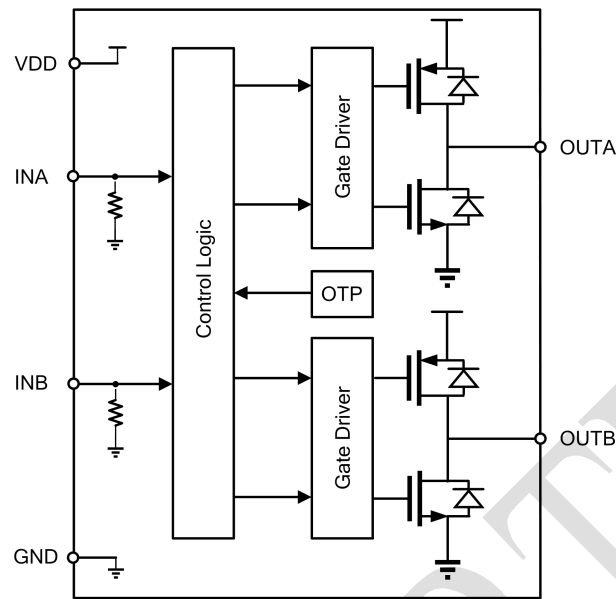

■ 引脚说明

DFN2x2-8	SOT23-6	E/SOP-8	符号	描述
2	6	1	OUTA	输出，将此引脚连接到电机绕组。
1	5	2,3	VDD	高压电源电压。需要使用一个去电容器来防止大的电压尖峰。
3	4	4	OUTB	输出，将此引脚连接到电机绕组。
4,9	2	5,8,9	GND	热 PAD 也是 GND。
6	1	6	INA	逻辑输入，带有一个大的内部下拉电阻。
5	3	7	INB	逻辑输入，带有一个大的内部下拉电阻。

**■ 输入逻辑真值表**

INA	INB	OUTA	OUTB	功能 (直流电动机)
L	L	Hi-Z	Hi-Z	惯性或停车
L	H	L	H	反向
H	L	H	L	正向
H	H	L	L	制动

CHIPNORTH



■ 绝对最大额定值

符号	参数	值	单位	
V _{VDD}	VDD 电源电压范围	-0.4 ~ +7	V	
V _{OUTx}	输出引脚电压范围	V _{IN}	V	
V _{INx}	输入引脚电压范围	GND-0.4 ~ +7	V	
T _J	最高结温	150	°C	
T _{STG}	储存温度范围	-55~160	°C	
θ _{JA} *	封装热阻 (环境结点)	DFN2x2-8	140	DFN2x2-8
		SOT23-6	180	SOT23-6
		SOP-8	160	SOP-8
		ESOP-8	80	ESOP-8
V _{ESD (HBM)}	静电放电电压 (人体模型)	4000	V	

*注：PCB 上有 8 平方厘米的铜箔。

■ 电气特性

测试条件：除非另有说明，否则 TA = 25°C，VDD = 6V。

参量	符号	条件	最小值	典型值	最大值	单位
工作电源电压	VDD		2.5		6.5	V
待机模式电源电流	I _{q0}	INA=INB=0V		0.1	1	μA
工作电源电流	I _{q1}	At least one input =3.3V		40	65	μA
输入高压	V _{IH}		2.3			V
输入低电压	V _{IL}				0.3	V
输入大电流	I _{IH}	V _{IN} =3.3V		3		μA
输入下拉电阻	R _{IN}			1.2		MΩ
HS 接通电阻	R _{hs}	I _{LOAD} =100mA		0.30	0.50	Ω
LS 接通电阻	R _{ls}	I _{LOAD} =100mA		0.15	0.25	Ω
输出使能时间	T ₁			150		ns
输出失能时间	T ₂			200		ns
延迟时间	T ₃	INx high to OUTx high		150		ns
	T ₄	INx low to OUTx low		350		ns
死的时间				200		ns
热关断阈值				155		°C
热关断磁滞				25		°C

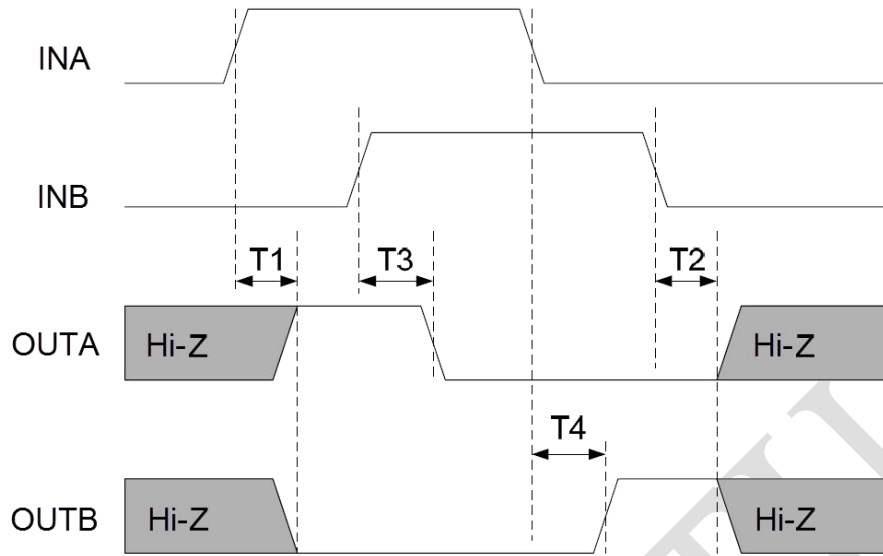

CHIPNORTH



Typical Characteristics

测试条件: TA=25° C, VIN=6V , Iload=0mA, 除非有特殊说明。

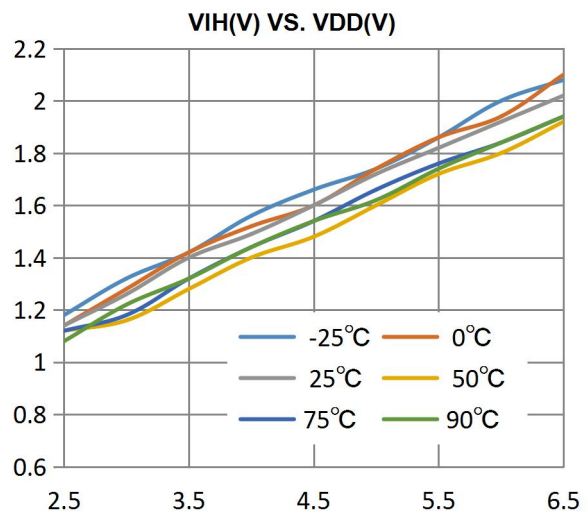
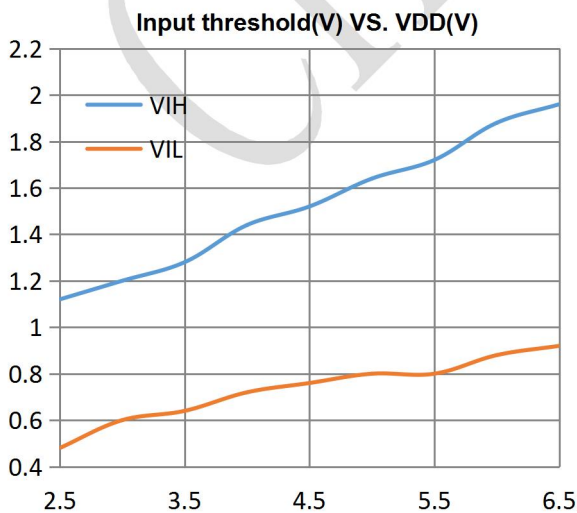
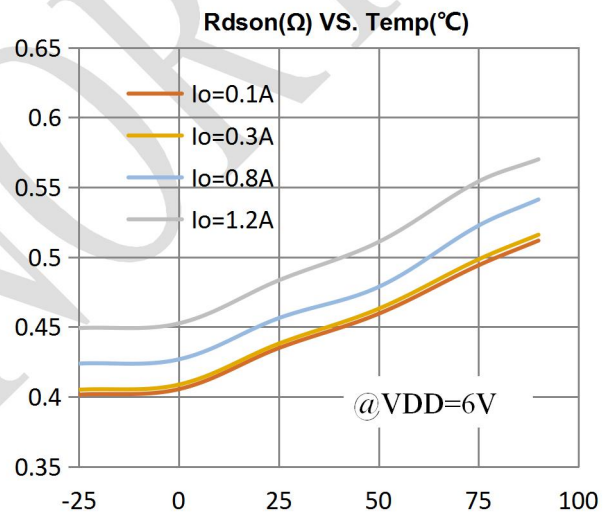
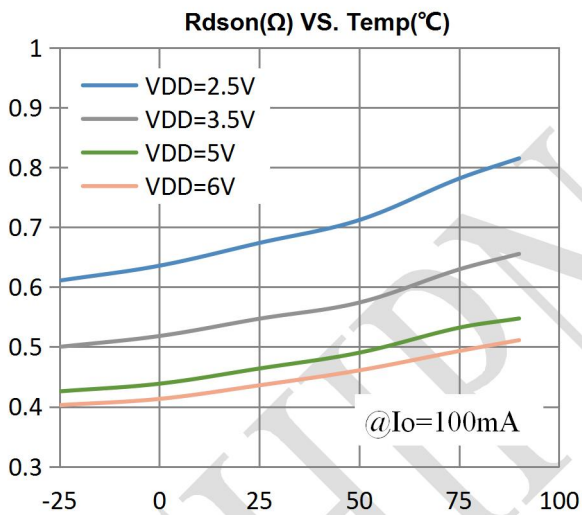
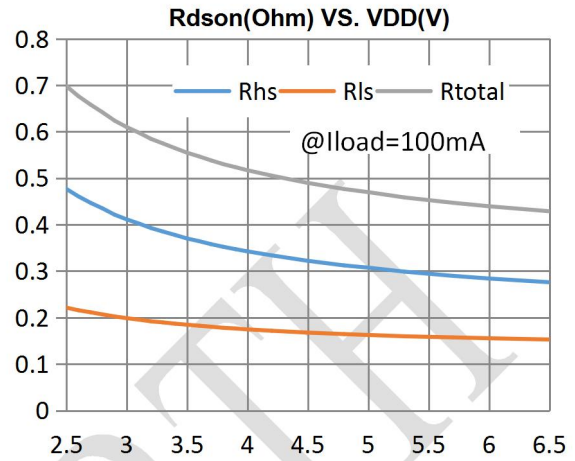
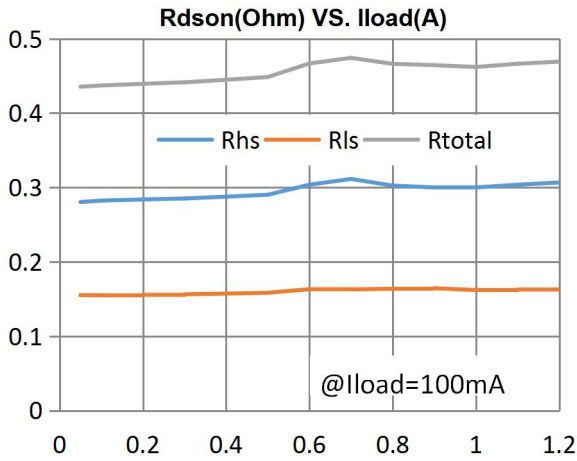

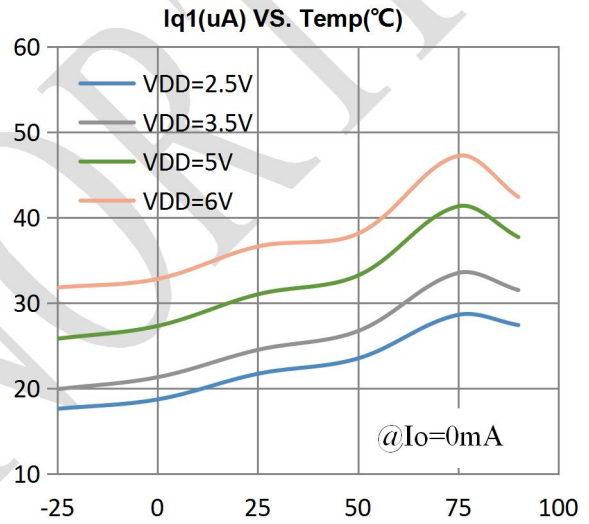
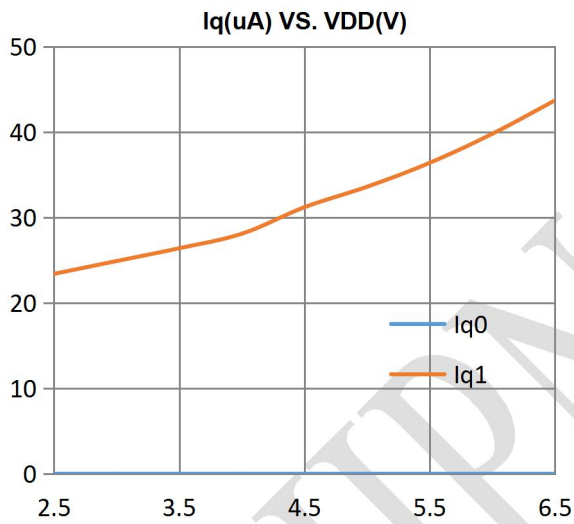
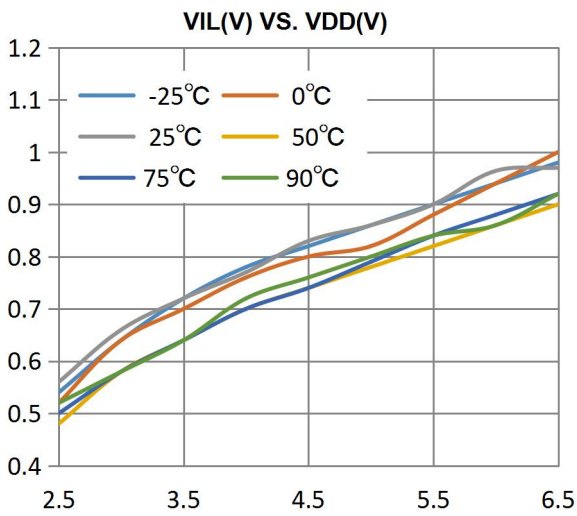

Output Enable Time T1

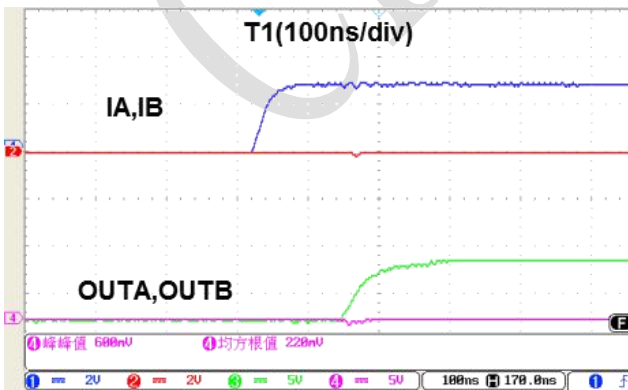

Output Enable Time T2

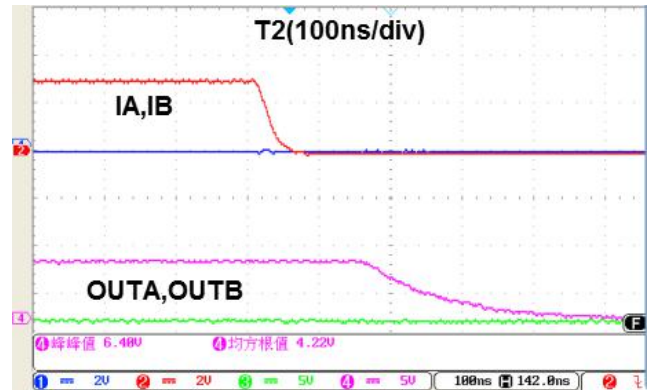



Delay Time T3

Delay Time T4

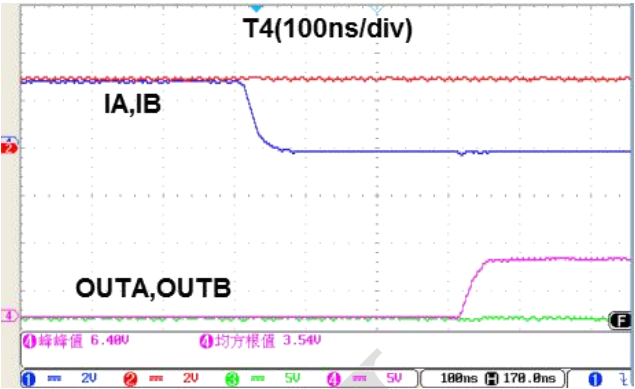
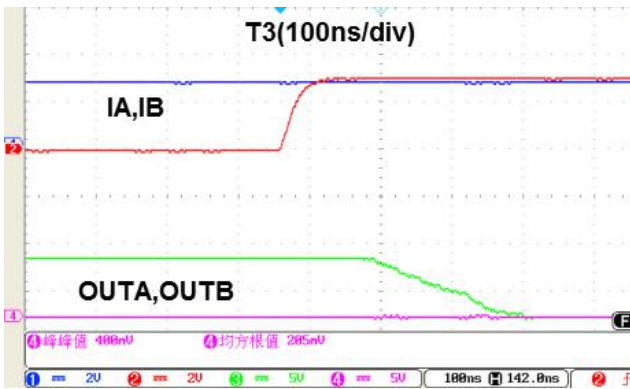

CHIPNORTH



■ 典型应用图

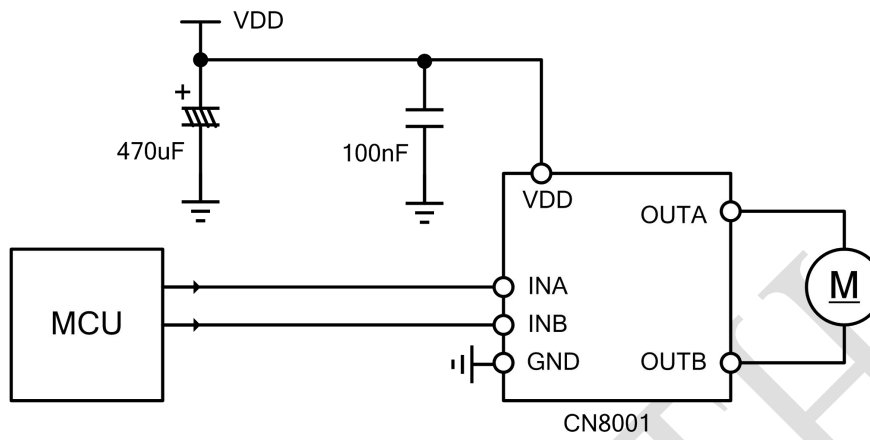

请确保输入信号 INA 和 INB 引脚在上电和掉电期间保持低电平。

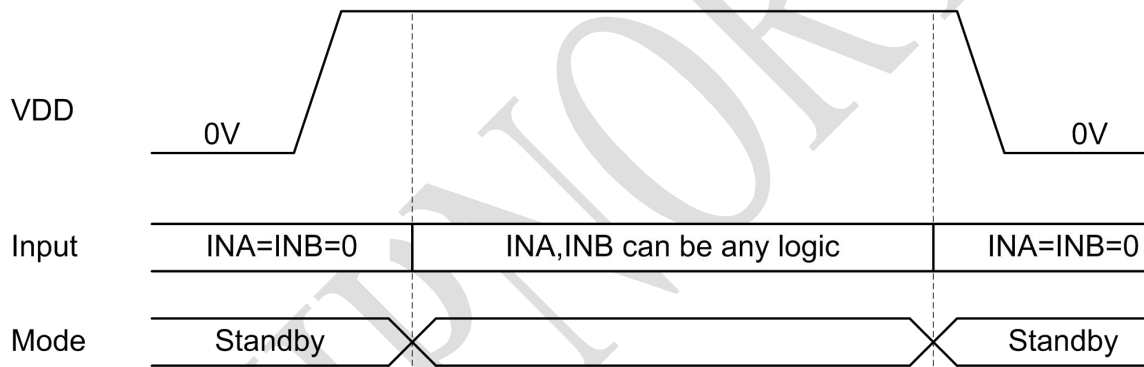



■ 封装信息

DFN2x2-8

标注	尺寸	最小(mm)	标准(mm)	最大(mm)	标注	尺寸	最小(mm)	标准(mm)	最大(mm)
A		0.70	0.75	0.80	e	0.50BSC			
A1		0.00	0.02	0.05	E	1.95	2.00		2.05
b		0.18	0.29	0.30	E2	0.70	0.75		0.80
c		0.20REF			L	0.25	0.30		0.35
D		1.95	2.00	2.05	h	0.10	0.15		0.20
D2		1.50	1.55	1.60	L/F载体尺寸 (mm): 1.00*1.80				

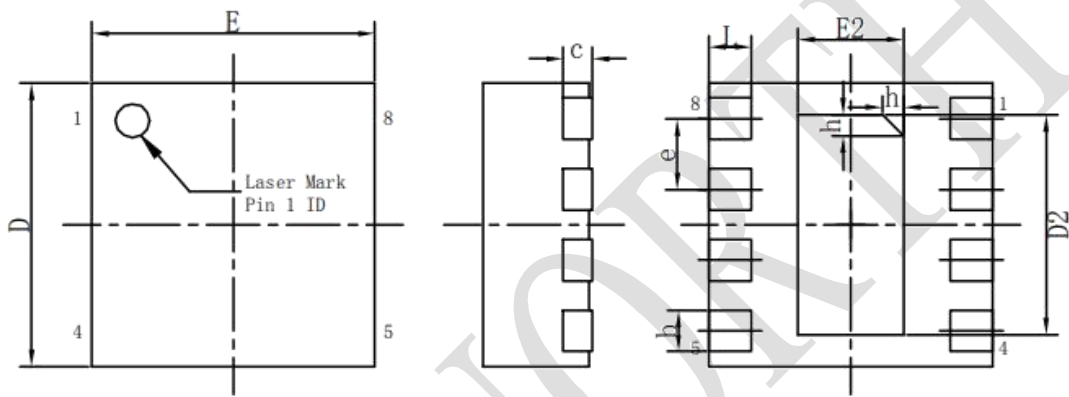

bottom view





SOT23-6

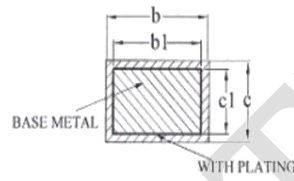
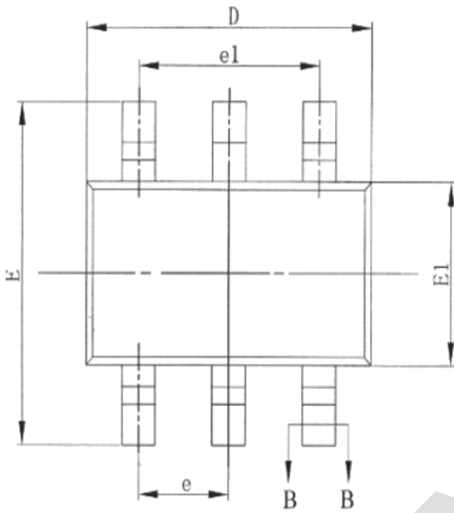
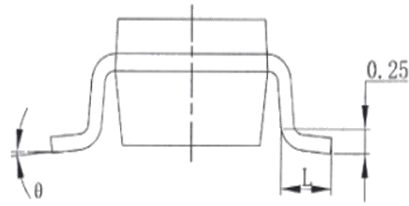
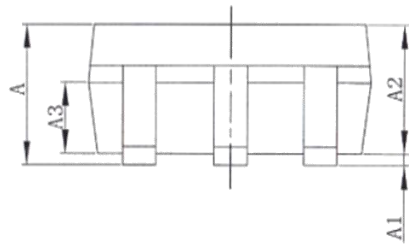

SECTION B-B



SYMBOL	MILLIMETER		
	MIN	NOM	MAX
A	—	—	1.25
A1	0.04	—	0.10
A2	1.00	1.10	1.20
A3	0.55	0.65	0.75
b	0.38	—	0.48
b1	0.37	0.40	0.43
c	0.11	—	0.21
c1	0.10	0.13	0.16
D	2.72	2.92	3.12
E	2.60	2.80	3.00
E1	1.40	1.60	1.80
e	0.95BSC		
e1	1.90BSC		
L	0.30	—	0.60
θ	0	—	8°



ESOP-8, SOP-8

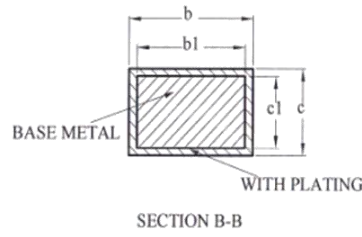
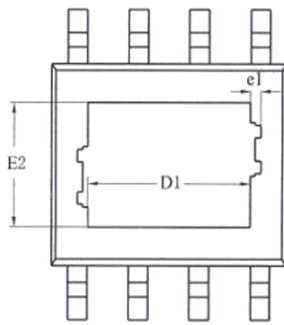

SYMBOL	MILLIMETER		
	MIN	NOM	MAX
A	—	—	1.65
A1	0.05	—	0.15
A2	1.30	1.40	1.50
A3	0.60	0.65	0.70
b	0.39	—	0.47
b1	0.38	0.41	0.44
c	0.20	—	0.24
c1	0.19	0.20	0.21
D	4.80	4.90	5.00
E	5.80	6.00	6.20
E1	3.80	3.90	4.00
e	1.27BSC		
h	0.25	—	0.50
L	0.50	0.60	0.80
L1	1.05REF		
θ	0	—	8°

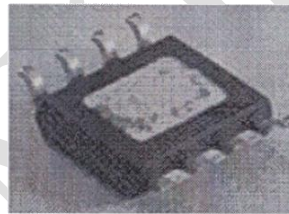
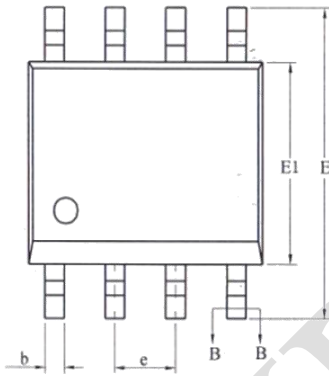
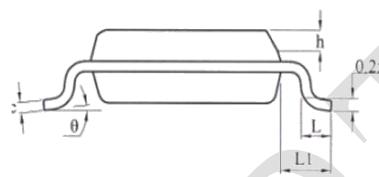
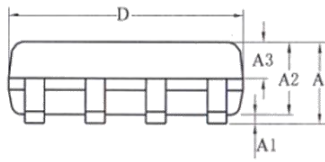

Size (mm) LP Size (mil)	D1	E2	e1
90*90	2.09REF	2.09REF	0.16REF
95*130	3.10REF	2.21REF	0.10REF



■ 版本修订

日期	版本号	修订说明	修订人
2020.3.20	V1.0	初始数据编写	张松峰

CHIPNORTH